

Ventilateurs Spécifiques



PRF
Page 114



EURO-P5000
Page 116



EURO-T5000
Page 116



KBR-KBT
Page 118



KTEX
Page 120



DKEX
Page 120



AWEX
Page 120



EX
Page 120





- Débit de 200 à 6 000 m³/h
- Volute en Polyéthylène et Turbine en Polypropylène
- Livré sur chaise en tôle d'acier peinte epoxy
- Fonctionnement de -15°C à +70°C
- Protection thermique moteur par thermocontact ou PTC

CARACTERISTIQUES TECHNIQUES

PRF	Unité	125-D2	160-D2	160-D4	160-E4	180-D2	180-D4
Tension	V/50Hz	400-3	400-3	400-3	230-1	400-3	400-3
Puissance max	W	250	750	250	140	1100	160
Intensité max	A	0.58	1.79	0.57	1.11	2.6	0.57
Débit maxi	m ³ /h	700	1670	775	775	2280	1150
Vitesse de rotation	min ⁻¹	2806	2869	1350	1330	2700	1360
Temp. maxi	°C	70	70	70	70	70	70
Pression sonore à 1m	dB(A)	59	66.8	46	4	69	49
Poid	kg	9	13	14	14	19	14
Classe moteur		F	F	F	F	F	F
Protection thermique		PTC	PTC	PTC	Th.contact	PTC	Th.contact
Indice de protection moteur	IP	55	55	54	54	55	54
Variateur 5 vitesses		FRQ5S-4A	FRQ5S-4A	FRQ5S-4A	RTRE 1.5	FRQ5S-4A	RTRD 2
Var. de fréquence 0-100%		FRQS-4A+MTP10	FRQS-4A+MTP10	FRQS-4A+MTP10	FRQS-4A+MTP10	FRQS-4A+MTP10	FRQS-4A+MTP10

PRF	Unité	180-E4	200-D2	200-D4	250-D2	250-D4
Tension	V/50Hz	230-1	400-3	400-3	400-3	400-3
Puissance max	W	140	1500	250	4000	750
Intensité max	A	1.11	3.26	0.95	7.77	2.5
Débit maxi	m ³ /h	1150	3370	1690	6560	3280
Vitesse de rotation	min ⁻¹	1365	2784	1413	2880	1374
Temp. maxi	°C	70	70	70	70	70
Pression sonore à 1m	dB(A)	49	74	59	86	66
Poid	kg	14	34	34	49	46
Classe moteur		F	F	F	F	F
Protection thermique		Th.contact	PTC	Th.contact	PTC	Th.contact
Indice de protection moteur	IP	54	55	54	55	54
Variateur 5 vitesses		RTRE 1.5	FRQ5S-4A	FRQ5S-4A	FRQ5S-10A	FRQ5S-4A
Var. de fréquence 0-100%		REE 2	FRQS-4A+MTP10	FRQS-4A+MTP10	FRQS-10A+MTP10	FRQS-4A+MTP10

DIMENSIONS

PRF	A	C	D	E	H	L	N	P	Q	R
125-D2	140	40	125	150	250	195	200	100	140	235
160-D2	183	40	160	180	310	210	255	100	140	290
160-D4/E4	183	40	160	180	310	190	255	100	140	290
180-D2	208	40	180	190	350	230	277	120	190	320
180-D4/E4	208	40	180	190	350	190	277	120	190	320
200-D2	240	40	200	200	410	245	320	150	230	355
200-D4	240	40	200	200	410	210	320	150	230	355
250-D2	290	40	250	240	495	340	330	170	250	370
250-D4	290	40	250	240	495	230	330	170	250	370

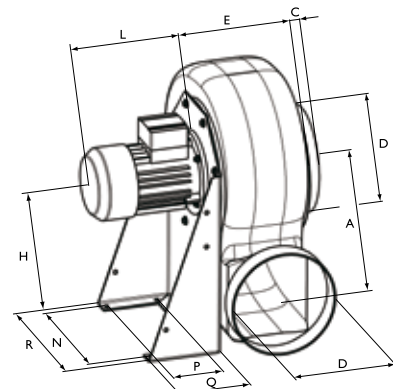

PERFORMANCES

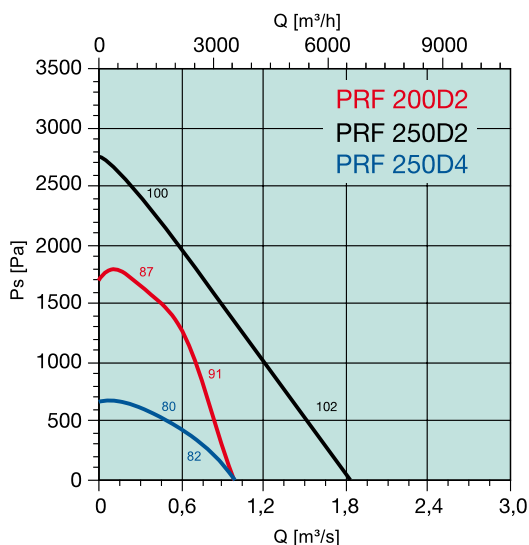
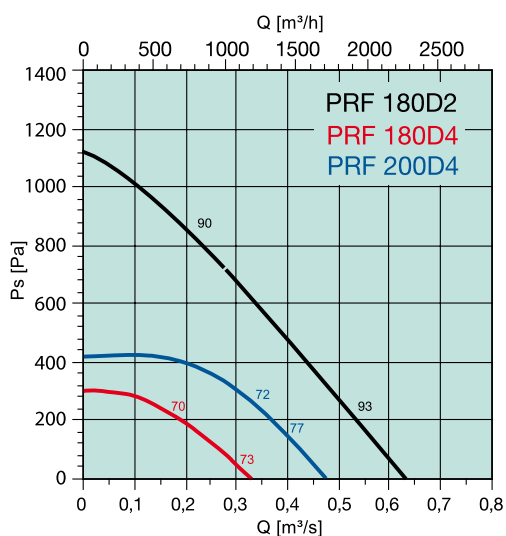
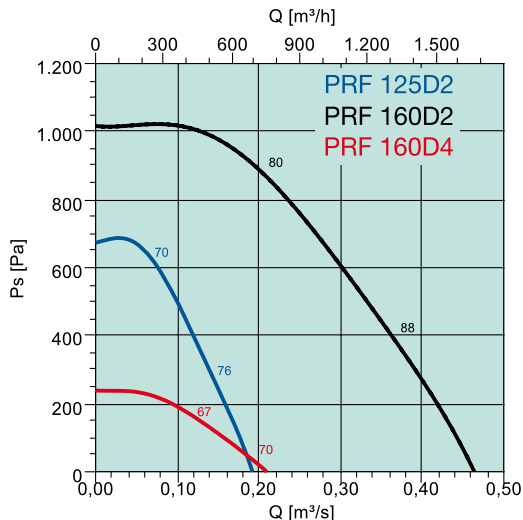
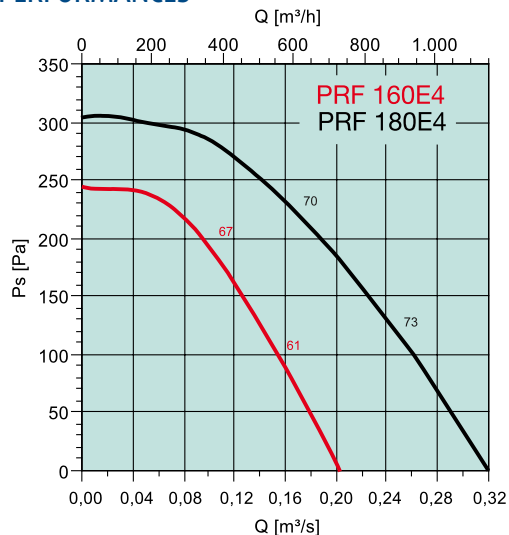

ACCESSOIRES



Manchette souple ASS-P



Clapet anti-retour VKA-P



Registre de réglage manuel VKS-P



Plots antivibrations RM

TARIF

Produits	Stock	Prix en €
Ventilateurs anti acide monophasé		
PRF 125E2 (1Ph/230V)		1 136,00
PRF 160E4 (1Ph/230V)		1 430,00
PRF 180E4 (1Ph/230V)		1 880,70
Ventilateurs anti acide triphasé		
PRF 125D2 (3Ph/400V)		863,80
PRF 160D4 (3Ph/400V)		1 204,40
PRF 160D2 (3Ph/400V) IE2		1 242,70
PRF 180D4 (3Ph/400V)		1 429,60
PRF 180D2 (3Ph/400V) IE2		1 430,00
PRF 200D4 (3Ph/400V)		1 661,40
PRF 200D2 (3Ph/400V) IE2		1 875,50
PRF 250D4 (3Ph/400V) IE2		2 358,30
PRF 250D2 (3Ph/400V) IE2		2 306,50

Accessoires	Stock	Prix en €
Manchettes souples		
ASS-P 125		47,80
ASS-P 160		56,50
ASS-P 180		58,70
ASS-P 200		63,20
ASS-P 250		73,90
Registres de réglage manuelle		
VKA-P 125		206,70
VKA-P 160		228,40
VKA-P 180		243,60
VKA-P 200		258,90
VKA-P 250		290,20
Clapets anti retour		
VKS-P 125		304,00
VKS-P 160		346,10
VKS-P 180		374,20
VKS-P 200		392,90
VKS-P 250		411,60
Variateur de fréquence		
5 vitesses		
FRQ5S-4A	●	1 920,00
FRQ5S-10A	●	2 200,00
0-10V*		
FRQS-4A	●	1 788,00
FRQS-10A	●	2 160,00
*Commande 0-10V pour FRQ		
MTP10	●	79,10

● En stock
⦿ Stock à confirmer



EURO P 5000 EP



EURO T 5000 ET

- Débit de 100 à 6 000 m³/h
- Construction polypropylène
- Régulation de vitesse par variateur de tension en version standard
- Protection moteur PMI en version standard
- Piquage pour raccordement circulaire et chaise inclus
- Version ATEX sur demande

CONSTRUCTION

La gamme de ventilateurs centrifuges plastiques EURO-P5000 comporte 13 modèles pour des débits de 150 à 6200 m³/h avec des pressions disponibles de 50 à 800 Pa. La turbine et la volute, en polypropylène, résistent aux acides et permettent l'utilisation de ces ventilateurs dans les ambiances agressives telles que laboratoires, industries chimiques, piscines. La température maximum de l'air véhiculé est de 40°C pour toutes les versions.

CARACTERISTIQUES (Sur chaise ou toiture)

Moteur IP55 Monophasé 230V 50Hz						
EP/ET	Puissance kW	Intensité A	Tr/min	Protection	Variateur	Poid kg
5102-M	0.18	1.8	2800	STET10B	Non réglable	8
5104-M	0.18	0.5	1400	STET10B	REE 1	8
5302-M	1.1	8.8	2800	STET10B	Non réglable	15
5304-M	0.18	0.8	1400	STET10B	REE 1	9
5306-M	0.18	2.5	950	STET10B	REE 4	9
5404-M	0.75	3.5	1400	STET10B	REE 4	15
5406-M	0.18	2.5	950	STET10B	REE 4	13
5604-M	0.75	3.2	1400	STET10B	REE 4	15
5606-M	0.18	1.3	950	STET10B	REE 2	13
5704-M	1.5	5	1400	STET10B	Non réglable	30
5706-M	0.55	2.3	950	STET10B	REE 4	22
5906-M	1.1	5	950	STET10B	Non réglable	42

Moteur IP55 Triphasé 400V 50Hz									
EP/ET	Puissance max kW	Intensité max A	Tr/min	Protection	Auto transf.	Variateur fréquence 0-100%	2 vit. manuelle	dB(A)	Poid kg
5102-T	0.18	0.8	2800	STDT16	Non réglable	FRQS-4A+MTP10	SDM250	57	8
5104-T	0.18	0.62	1400	STDT16	RTRD2	FRQS-4A+MTP10	SDM250	45	8
5302-T	1.1	2.6	1800	STDT16	Non réglable	FRQS-4A+MTP10	SDM250	70	15
5304-T	0.18	0.62	1400	STDT16	RTRD2	FRQS-4A+MTP10	SDM250	57	9
5306-T	0.18	1	950	STDT16	RTRD2	FRQS-4A+MTP10	SDM250	45	9
5404-T	0.75	1.2	1400	STDT16	RTRD2	FRQS-4A+MTP10	SDM250	58	15
5406-T	0.18	1	950	STDT16	RTRD2	FRQS-4A+MTP10	SDM250	57	13
5604-T	0.75	1.2	1400	STDT16	RTRD2	FRQS-4A+MTP10	SDM250	58	15
5606-T	0.18	1	950	STDT16	RTRD2	FRQS-4A+MTP10	SDM250	57	13
5704-T	1.5	2.3	1400	STDT16	RTRD4	FRQS-4A+MTP10	SDM250	65	30
5706-T	0.55	1.8	950	STDT16	RTRD4	FRQS-4A+MTP10	SDM250	60	22
5904-T	4	8	1400	STDT16	RTRD14	FRQS-10A+MTP10	SDM250	70	55
5906-T	1.1	3.1	950	STDT16	RTRD14	FRQS-4A+MTP10	SDM250	65	42

ACCESSOIRES



Protection thermique
S-ET 10



Autotransformateur
5 positions RTRE
avec protection moteur
PMI



Protection thermique
STDT16



Autotransformateur
5 positions RTRD
avec protection
moteur PMI

COURBES DEBIT/PRESSION

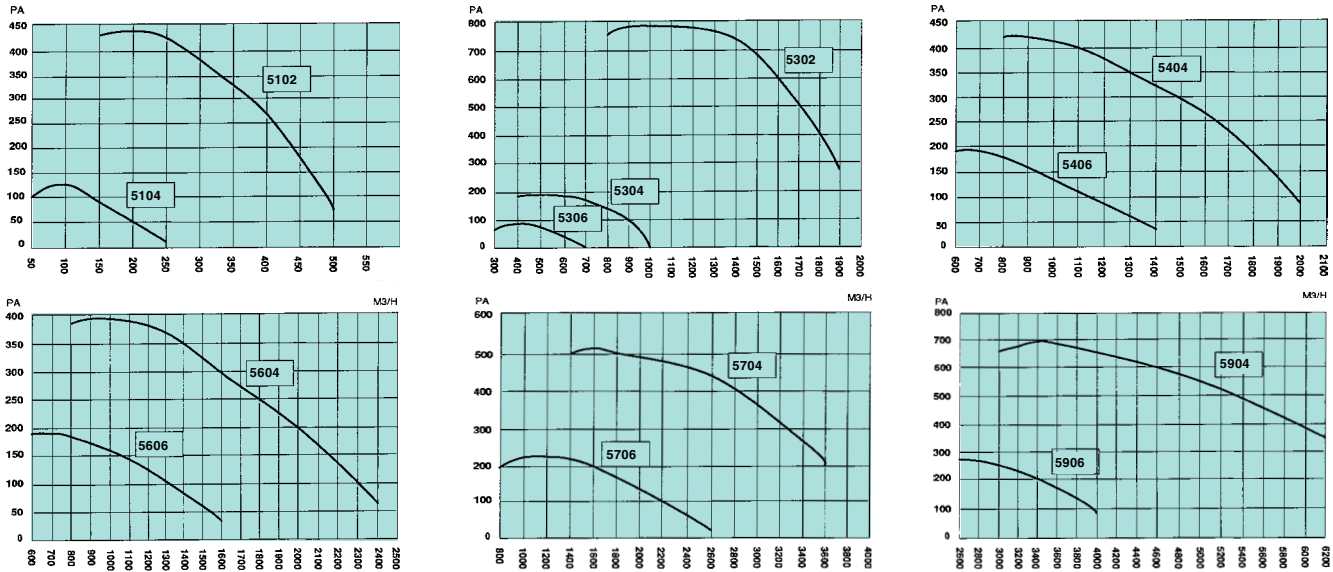

DIMENSIONS

Modèle pour chaise												
EP	A	B	C	C*	D	E	F	G	H	I	J	K
5102	125	125	313	363	382	189	63	130	103	189	136	325
5104	125	125	313	363	382	189	63	130	103	189	136	325
5302	200	200	460	510	580	300	80	200	148	300	201	501
5304	200	200	460	510	563	300	63	200	148	300	201	501
5306	200	200	460	510	563	300	71	200	148	300	201	501
5404	200	250	545	595	550	220	80	250	182	220	236	456
5406	200	250	545	595	550	220	71	250	182	220	236	456
5604	250	250	525	575	650	320	80	250	185	320	250	428
5606	250	250	525	575	650	320	71	250	185	320	250	428
5704	250	315	605	655	645	245	81	310	222	245	300	545
5706	250	315	605	655	645	245	70	310	222	245	300	545
5904	355	355	700	750	205	485	100	320	259	485	353	838
5906	355	355	700	750	205	485	Mono 100 TRI 90	320	259	485	353	838

VENTILATEUR SUR CHAISE

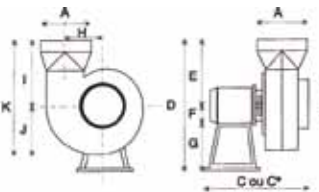

VENTILATEUR DE TOITURE

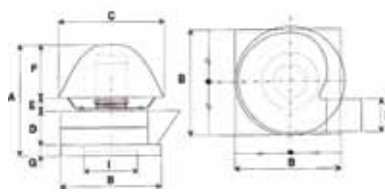

Modèle pour toiture										
ET	A	B	C	D	E	F	G	H	I	kg
5102	405	300	380	90	70	190	55	90	125	12
5104	405	300	380	90	70	190	55	90	125	12
5302	470	400	435	135	60	225	50	230	200	35
5304	470	400	435	135	60	225	50	230	200	19
5306	470	400	435	135	60	225	50	230	200	19
5604	520	500	435	165	80	225	50	290	250	36
5606	520	500	435	165	80	225	50	290	250	24
5704	620	600	435	205	120	225	70	355	315	57
5706	620	600	435	205	120	225	70	355	315	57
5904	780	700	740	240	150	320	70	412	315	65
5906	780	700	740	240	150	320	70	412	315	65

Produits	Prix en €	Accessoires	Prix en €
Ventilateurs standard monophasé		Capots moteur PVC	
EP5102M	868,30	PCM100	93,20
EP5104M	867,20	PCM300	113,80
EP5302M	1 198,00	PCM400	113,80
EP5304M	964,70	PCM600	113,80
EP5306M	1 101,80	PCM700	113,80
EP5404M	1 294,30	PCM900	241,90
EP5406M	1 206,20	Sorties rondes à grille PVC	
EP5604M	1 448,00	SOR125	61,40
EP5606M	1 417,40	SOR160	86,50
EP5704M	2 318,70	SOR200	111,90
EP5706M	2 173,10	SOR250	122,80
EP5906M	3 021,60	SOR315	137,00
Ventilateurs standard triphasé		Registre de réglage PVC	
EP5102T	847,20	PERG125	269,20
EP5104T	1 187,30	PERG160	269,20
EP5302T	1 147,50	PERG200	379,60
EP5304T	1 171,20	PERG250	467,20
EP5306T	964,70	PERG315	560,20
EP5404T	1 269,60	PERG355	701,70
Tourelles standard monophasé		Réductions coniques PVC	
ET5102M	1 196,90	PERD160X125	75,90
ET5104M	1 124,20	PERD200X160	126,60
ET5302M	1 445,60	PERD250X200	158,80
ET5304M	1 448,00	PERD315X250	208,20
ET5306M	1 687,40	PERD355X315	146,10
ET5604M	1 929,00	Coupe de proximité	
ET5606M	2 089,90	CLPROX20(6.5kW)	76,90
ET5704M	3 024,00	Protection thermique	
ET5706M	2 949,90	S-ET 10 Monophasé	99,10
ET5906M	5 531,50	STDT-16 Triphasé	249,40
Tourelles standard triphasé		Variateurs de vitesse monophasé	
ET5102T	1 155,80	Modèle 4 et 6 pôles uniquement	
ET5104T	1 087,80	RTRE 1.5	208,40
ET5302T	1 402,20	RTRE 3	254,40
ET5304T	1 448,00	RTRE 5	315,50
ET5306T	1 669,80	RTRE 7	416,20
ET5604T	1 958,30	Variateurs de vitesse triphasé	
ET5606T	2 071,20	Modèle 4 et 6 pôles uniquement	
ET5704T	2 896,10	RTRD 2	524,60
ET5706T	2 898,40	RTRD 4	769,60
ET5904T	5 757,90	RTRD 7	938,20
ET5906T	5 294,50	RTRD 14	1 501,80
		Variateur de fréquence	
		5 vitesses	
		FRQ55-4A	1 920,00
		FRQ55-10A	2 200,00
		0-10V*	
		FRQS-4A	1 788,00
		FRQS-10A	2 160,00
		*Commande 0-10V pour FRQ	
		MTP10	79,10

● En stock
○ Stock à confirmer





- Flux d'air jusqu'à 120°C
- Facilité d'accès (porte pivotante)
- Moteurs réglables
- Isolation 50 mm (laine de roche)
- Version 400°C/2h sur demande

CARACTERISTIQUES

KBR/KBT	Tension V/50Hz	Puissance max kW	Intensité max A	t/min	dB(A) 1 m	Poids kg	Classe moteur	Variateur 5 vit.	Prot. therm.
KBT turbine A action									
160-E4	230 1~	0,14	1,11	1330	49	25	F	RTRE1,5	S-ET 10
160-DV	400 3~	0,16	0,57	1120	49	24	F	RTRE2	STDT16
180-E4	230 1~	0,3	2,1	1330	50	29	F	RTR3	S-ET 10
200-DV	400 3~	0,55	1,94	1420	53	38	F	RTRD4	STDT16
200-E4	230 1~	0,55	4	1370	53	35	F	RTRE5	S-ET 10
225-DV	400 3~	0,75	2,5	1350	57	38	F	RTRD4	STDT16
225-E4	230 1~	0,75	5,4	1380	57	40	F	RTRE7	S-ET 10
250-DV	400 3~	1,5	4,3	1330	61	51	F	RTRD7	STDT16
250-E4	230 1~	1,84	13,7	1360	61	52	F	-	S-ET 10
250-DV	400 3~	2,2	5,8	1420	64	68	F	RTRD7	STDT16
KBR turbine A reaction									
315-DZ	400 3~	1,5	3,4	2800	67	75	F	RTRD4	STDT16
315-DV	400 3~	0,37	1,39	1460	52	72	F	RTRD2	STDT16
355-DZ	400 3~	3	6,5	2840	70	100	F	RTRD7	STDT16
355-DV	400 3~	0,37	1,39	1410	57	81	F	RTRD2	STDT16
355-E4/K	230 1~	0,37	2,1	1330	59	80	F	RTRD3	S-ET 10
355-DV/K	400 3~	0,37	1,39	1360	59	81	F	RTRD2	STDT16
355-DZ/K	400 3~	2,2	5	2660	72	100	F	RTRD7	STDT16
355-E4	230 1~	0,37	2,1	1330	59	81	F	RTRE3	S-ET 10

DIMENSIONS

KBT	A	B	C	D	E	L	R	T	ØA	n
160	435	382	207	213	248	450	435	149	160	127,4
180	470	412	219	230	269	450	470	161	200	134,4
200	510	445	232	249	292	450	510	174	200	142,7
225	522	455	251	256	301	600	522	193	225	146,5
250	576	500	272	282	333	600	576	213	250	161,5
280	625	537	295	295	360	600	625	234	280	171,5
KBR										
315	690	600	307	339	398	800	690	249	315	187,5
355	770	655	331	372	451	800	770	273	355	206,7

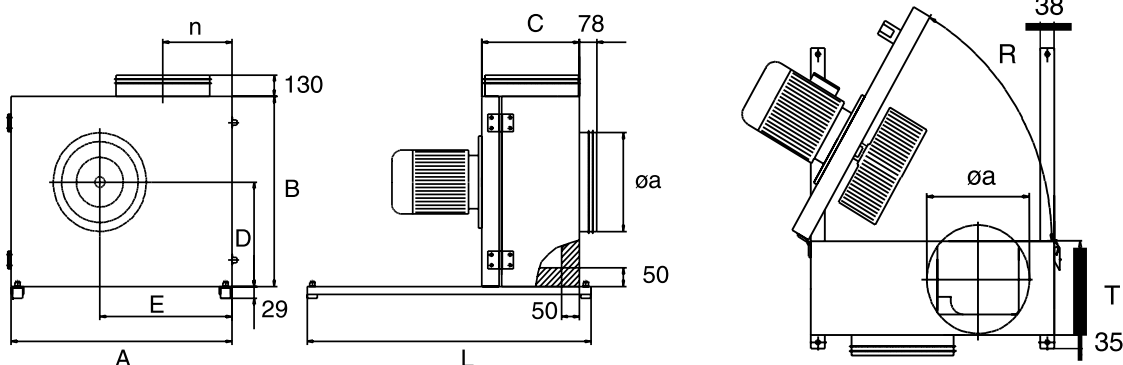

PERFORMANCES

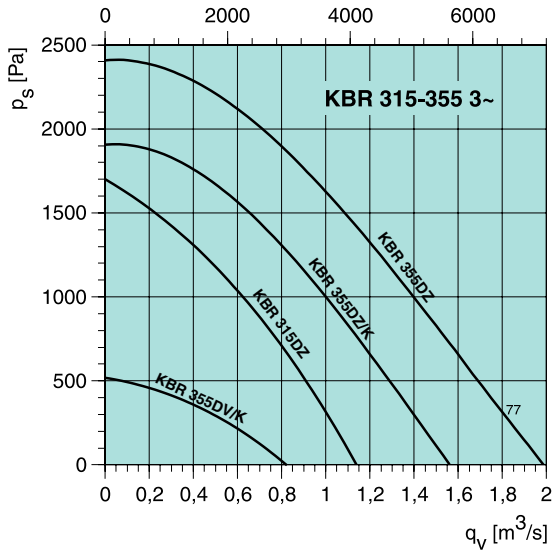
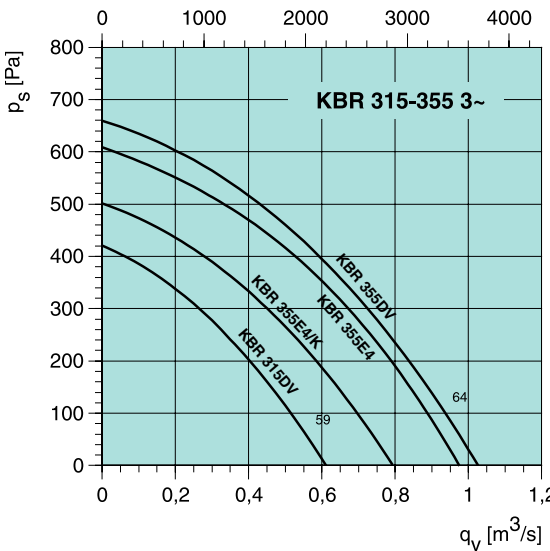
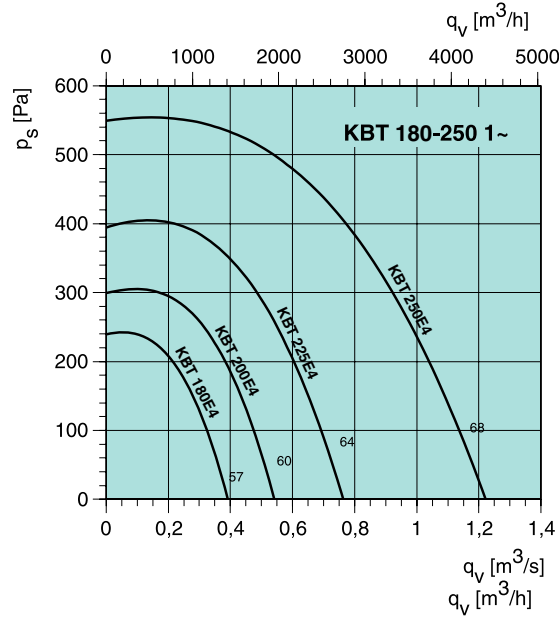
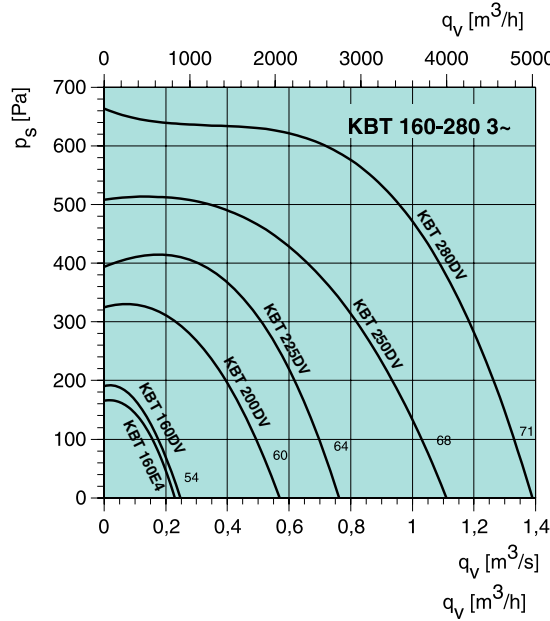

TARIF

Produits	Stock	Prix en €
Ventilateurs à action monophasés		
KBT 160E4		2 019,60
KBT 180E4		2 179,30
KBT 200E4		2 138,10
KBT 225E4		2 145,70
KBT 250E4		2 524,50
Ventilateurs à action triphasés		
KBT 160DV		1 932,00
KBT 200DV		2 024,60
KBT 225DV		2 042,60
KBT 250DV		2 218,00
KBT 280DV		2 560,40
Ventilateurs à réaction monophasés		
KBR 355E4/K		2 587,10
KBR 355E4		2 631,80
Ventilateurs à réaction triphasés		
KBR 315DV		2 666,80
KBR 315DZ		2 708,30
KBR 355DV		2 893,00
KBR 355DV/K		2 981,60
KBR 355DZ		3 023,10
KBR 355DZ/K		3 111,40

Accessoires	Stock	Prix en €
Capots de protection KBR/KBT		
WSD/KBT-1		49,10
WSD/KBT-2		60,00
Coupeure de proximité		
CLPROX20(6.5kW)	●	76,90
Pressostat 30-500Pa avec tubes 2m + 2 prises de pression		
PST1	●	96,00
Pressostat 20-300Pa avec tubes 2m + 2 prises de pression		
PST2	●	96,00
Manchettes de raccordement		
FK 125	●	13,80
FK 160	●	14,70
FK 200	●	15,80
FK 250	●	18,00
FK 315	●	21,20
Cassette + Filtre G3		
FGR 160.3	●	102,10
FGR 200.3	●	115,60
FGR 250.3	●	134,70
FGR 315.3	●	158,30
Cassette + Filtre EU5		
FFR 160.5		205,70
FFR 200.5		246,10
FFR 250.5		299,50
FFR 315.5		320,40

Accessoires	Stock	Prix en €
Grilles de protection		
SG 160	●	10,10
SG 200	●	11,80
SG 250	●	18,00
SG 315	●	20,80
Silencieux		
LDC160.600	●	88,30
LDC160.900	●	114,20
LDC200.600	●	103,10
LDC200.900	●	137,80
LDC315.900	●	214,10
Variateurs de vitesse monophasés		
RTRE 1.5	●	208,40
RTRE 3	●	254,40
RTRE 5	●	315,50
RTRE 7	●	416,20
Variateurs de vitesse triphasés		
RTRD 2	●	524,60
RTRD 4	●	769,60
RTRD 7	●	938,20
RTRD 14	●	1 501,80

● En stock
○ Stock à confirmer

COURBES DEBIT/PRESSION



KTEX

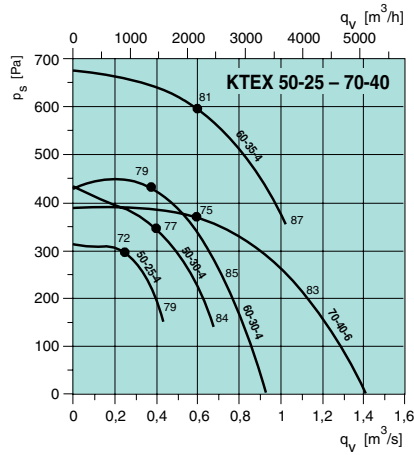

Produits	Prix en €
Ventilateurs	
KTEX 50-25-4	1 306,00
KTEX 50-30-4	1 816,30
KTEX 60-30-4	1 911,40
KTEX 60-35-4	2 300,70
KTEX 70-40-6	2 707,10
Autotransformateur triphasé	
R-DK4KT	967,70



DKEX

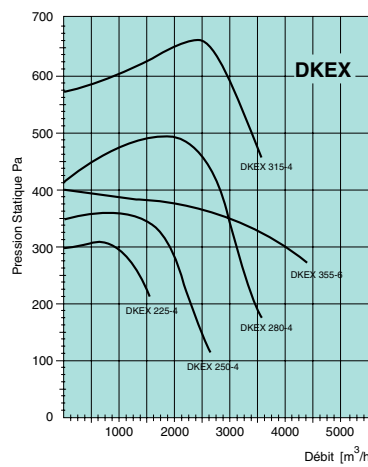
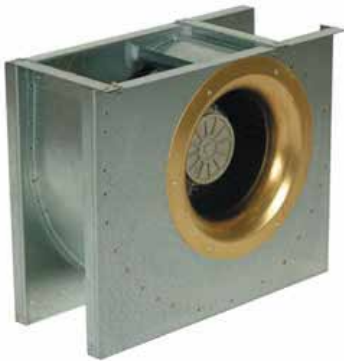

Produits	Prix en €
Ventilateurs	
DKEX 225-4	1 092,80
DKEX 250-4	1 629,80
DKEX 280-4	1 722,20
DKEX 315-4	2 115,70
DKEX 355-6	2 334,40
Autotransformateur triphasé	
R-DK4KT	967,70



AWEX

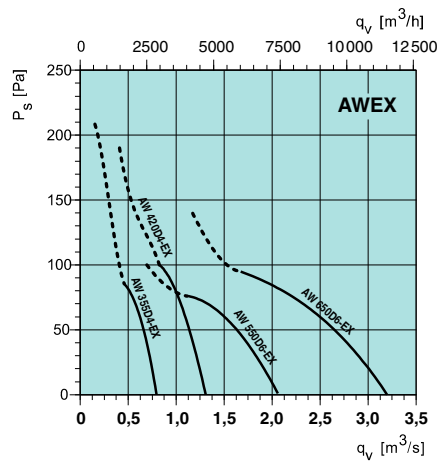

Produits	Prix en €
Ventilateurs	
AW 355D4-EX	1 448,40
AW 420D4-EX	1 579,40
AW 550D6-EX	1 768,30
AW 650D6-EX	2 636,60
Autotransformateur triphasé	
R-DK4KT	967,70



EX

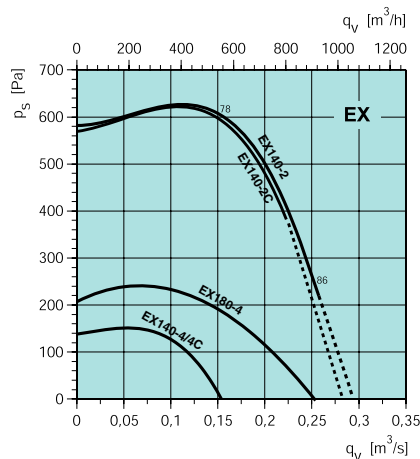

Produits	Prix en €
Ventilateurs	
EX 140-2	969,20
EX 140-2C	1 135,60
EX 140-4	901,40
EX 140-4C	1 056,70
EX 180-4	929,10
EX 180-4C	1 084,30

● En stock
○ Stock à confirmer